

WILDROCK

Natural stone wall tiles/ Настенная плитка из натурального камня

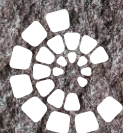

NEOLITH
EVOLUTION OF STONE

WILDROCK

Каталог продукции

WILDROCK – это коллекция с природной фактурой. Настоящий экостиль в стеновых покрытиях. Здесь собран широкий ассортимент природного камня: известняки, кварциты, песчаники, доломиты. Камни с натуральной теплой фактурой, но достаточно прочные для создания надежных покрытий стен. Цоколи, внутренние и наружные стены из натурального камня – все примет неповторимый теплый и в то же время мощный фундаментальный вид.

NEOLITH 2016



Лемезит



Песчаник

Плитняки – камни с самой яркой природной фактурой. Все их разнообразие : известняки, песчаники, кварциты мы объединили в одну серию – WILDROCK. Сегодня в коллекцию входят пять камней – лемезит, песчаник, кварцит, златолит и доломит.

Лемезит – это мраморизованный строматолитовый известняк красных оттенков – от светло-красного до вишневого, добываемый в горах Урала, имеющий шероховатую поверхность.

Песчаник – камень осадочного происхождения, добываемый в Ростовской области. Благодаря особенностям образования это достаточно прочный для мощения материал.

Кварцит и Златолит – еще два камня уральских гор. Геологическое название плитняка Златолита или сланца — слюдястый или слюдянистый кварцит, народные - златолит или златалит. Златолит является названием одного из видов кварцита – серицита. В состав златолита входят разнообразные минералы и металлы слюда, гранат, мусковит, турмалин, а так же серебро и золото.

Доломит – достаточно прочная горная порода. Благодаря включениям кальцита имеет интересный рисунок. Доломит обладает теплым охристым цветом.

Камни для коллекции WILDROCK обладают каждый своим уникальным рельефом и цветовой гаммой, что позволило создать нам уникальную коллекцию стеновой плитки с неповторимым природным колоритом и прекрасными экологическими свойствами.



Кварцит



Златолит



Доломит

WILDROCK

ФОРМАТЫ

Лемезит



200x200



150x150



100x100



50x50



50xL



50xL Природный



25-50xL Торцевой срез



150x250



150x200



75x300



100x250



100x200



100x150



75x250



75x200



75x150



75x100



50x250



50x200



50x150



50x100



25x250

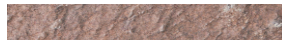

25x200



25x150



25x100



150x150



100x100



50x50



100x150



75x100



50x100



плоский булыжник

Старенные

Примечание. Возможная толщина всех элементов: 15-20 мм, 20-25 мм.

Песчаник



200x200



150x150



100x100



50x50



50xL

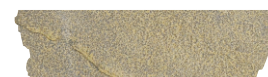

50xL Природный



25-50xL Торцевой срез

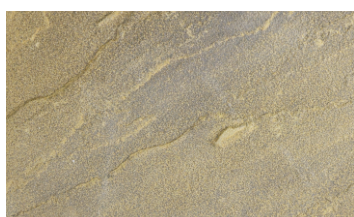

150x250



150x200



75x300



100x250



100x200



100x150



75x250



75x200



75x150



75x100



50x250



50x200



50x150



50x100



25x250



25x200



25x150



25x100



150x150



100x100



50x50

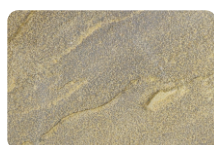

100x150



75x100



50x100



гlossкий булыжник

Старенные

Примечание. Возможная толщина всех элементов: 15-20 мм, 20-25 мм.

WILDROCK

ФОРМАТЫ

Кварцит



200x200



150x150



100x100



50x50

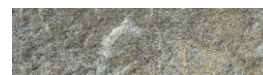

50xL

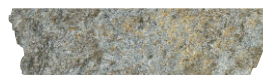

50xL Природный



25-50xL Торцевой срез



150x250



150x200

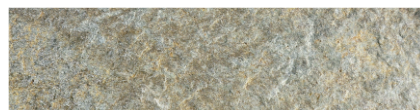

75x300



100x250



100x200



100x150

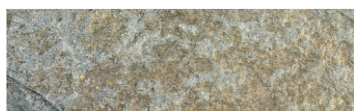

75x250



75x200



75x150



75x100

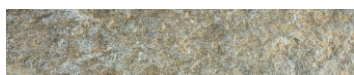

50x250



50x200



50x150



50x100



25x250

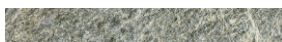

25x200



25x150



25x100



150x150



100x100



50x50

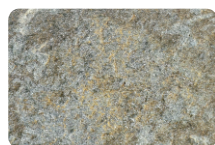

100x150

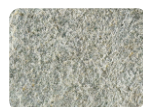

75x100



50x100



гладкий булыжник

Старенные

Примечание. Возможная толщина всех элементов: 15-20 мм, 20-25 мм.

Златолит



200x200



150x150



100x100



50x50



50xL



50xL Природный



25-50xL Торцевой срез



150x250



150x200



75x300



100x250



100x200



100x150



75x250



75x200



75x150



75x100

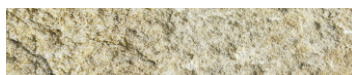

50x250



50x200



50x150



50x100



25x250



25x200



25x150



25x100



150x150



100x100



50x50



100x150



75x100



50x100



гlossкий булыжник

Старенные

Примечание. Возможная толщина всех элементов: 15-20 мм, 20-25 мм.

WILDROCK

ФОРМАТЫ

Доломит



200x200



150x150



100x100



50x50



50xL



50xL Природный



25-50xL Торцевой срез



150x250



150x200



75x300



100x250



100x200



100x150



75x250



75x200



75x150



75x100



50x250



50x200



50x150



50x100



25x250



25x200



25x150



25x100



150x150



100x100



50x50



100x150



75x100



50x100



плоский булыжник

Старенные

Примечание. Возможная толщина всех элементов: 15-20 мм, 20-25 мм.

WILDROCK

ВАРИАНТЫ УКЛАДКИ

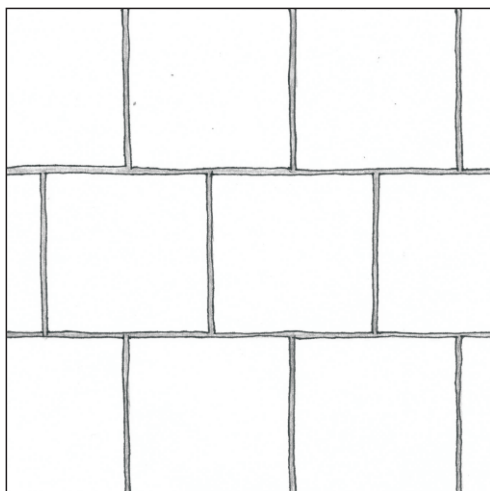

0001 ■ 200x200

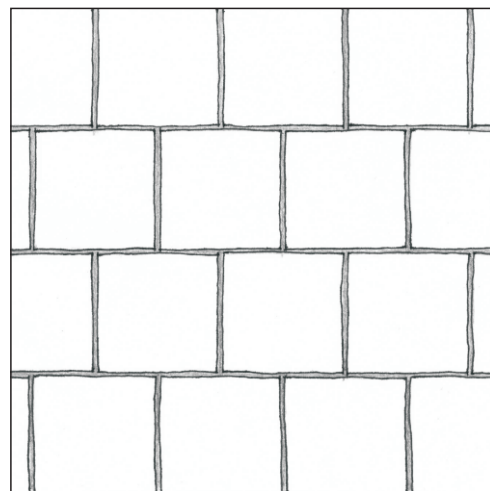

0002 ■ 150x150

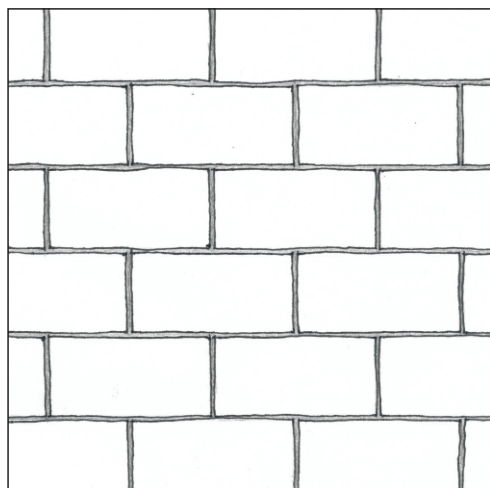

0003 ■ 100x200

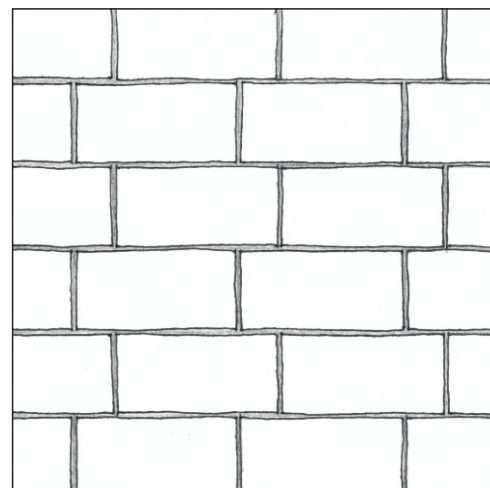

0004 ■ 100x200

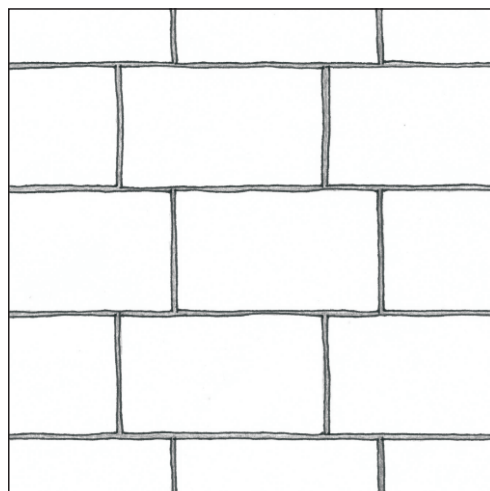

0005 ■ 150x250

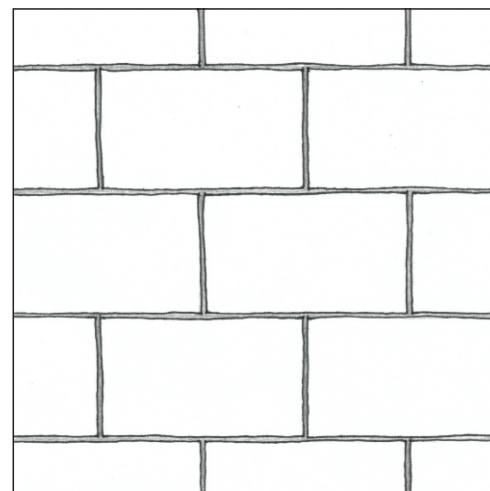

0006 ■ 150x250

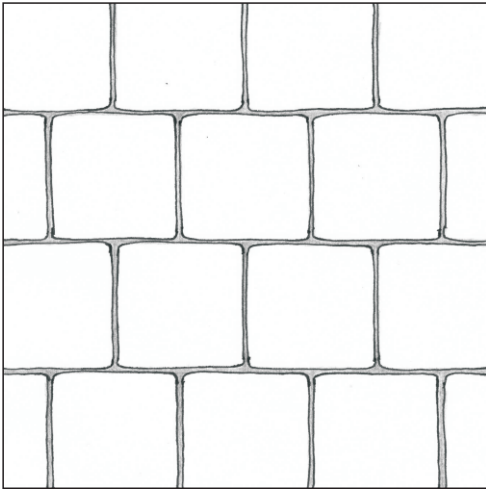

0007 ■ 150x150 Старённая

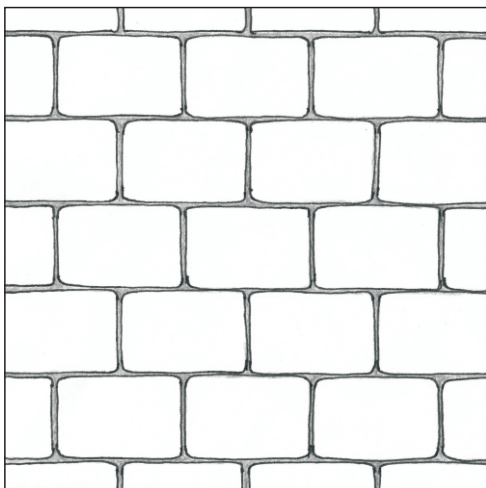

0008 ■ 100x150 Старённая

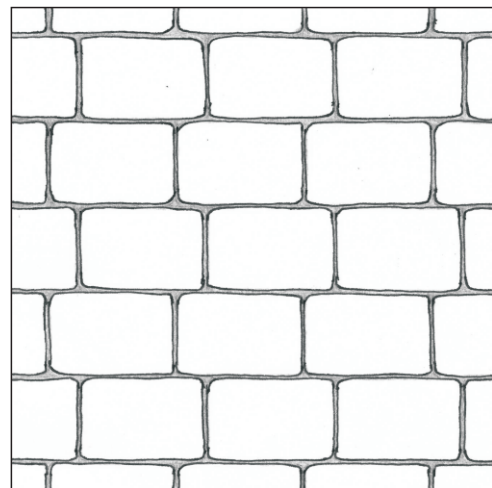

0009 ■ 100x150 Старённая

WILDROCK

ВАРИАНТЫ УКЛАДКИ

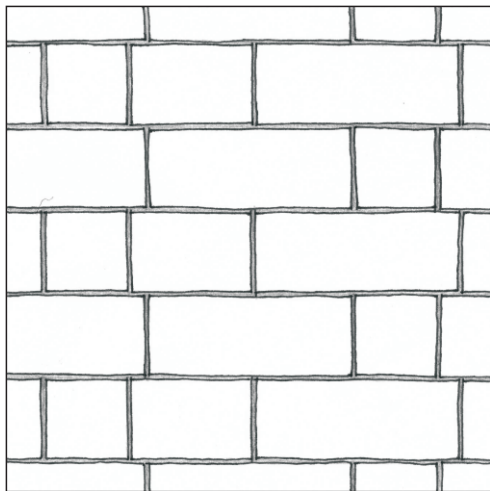

0010 ■ 100x250, 100x150, 100x100

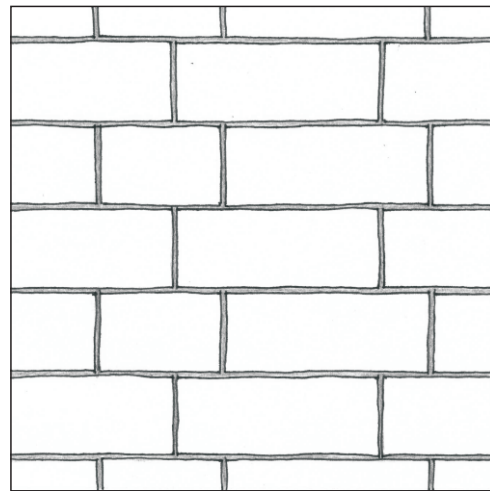

0011 ■ 100x250, 100x150

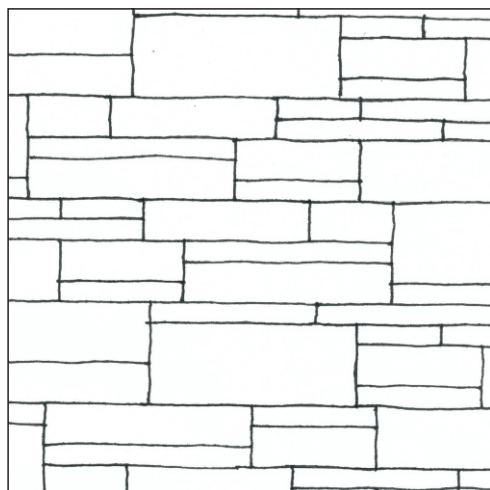

0012 ■ 100x250, 75x250, 75x200, 50x250, 50x150, 25x250, 25x200, 25x150, 25x100

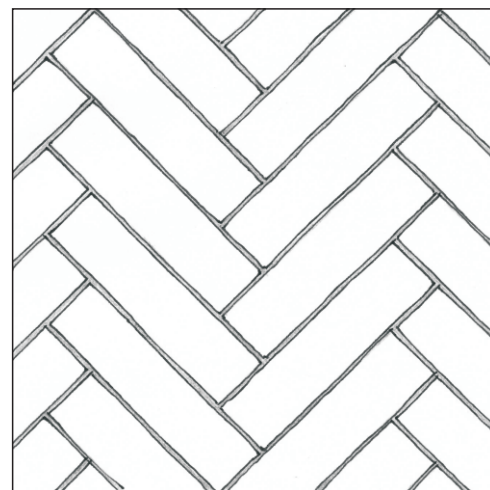

0013 ■ 75x300

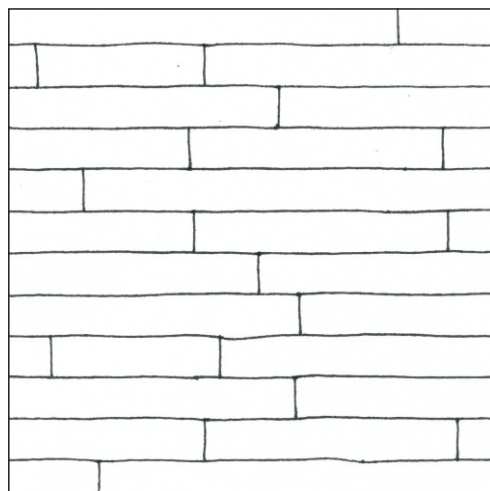

0014 ■ 50xL

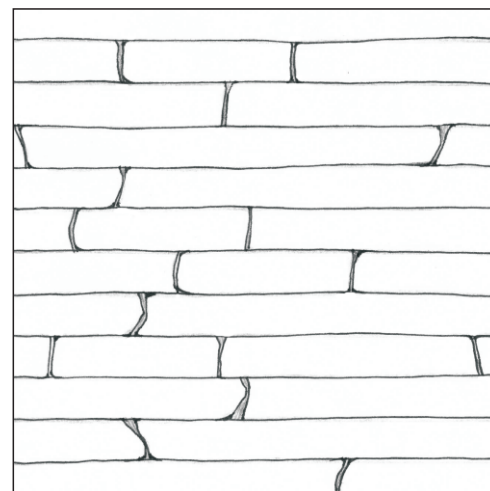

0015 ■ 50xL

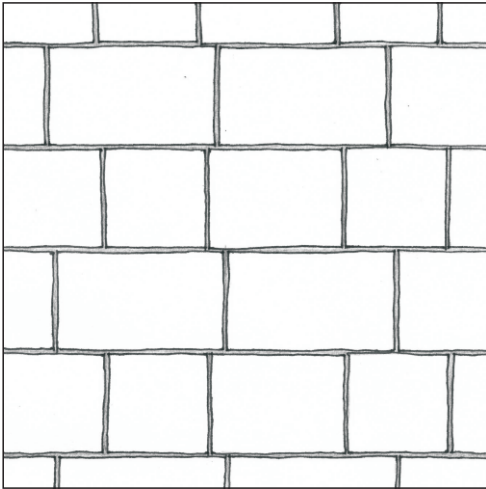

0016 ■ 150x250, 150x200, 150x150

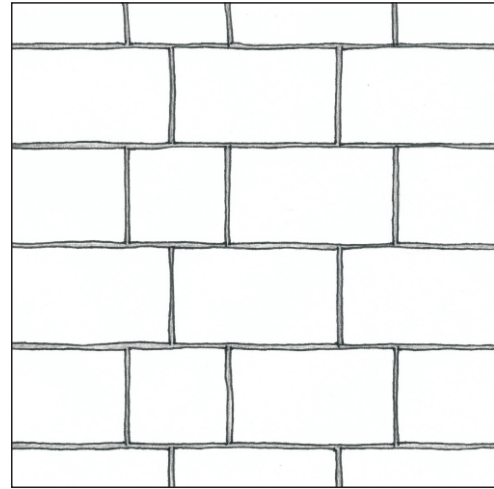

0017 ■ 150x250, 150x150

Примечание: швы 5 мм

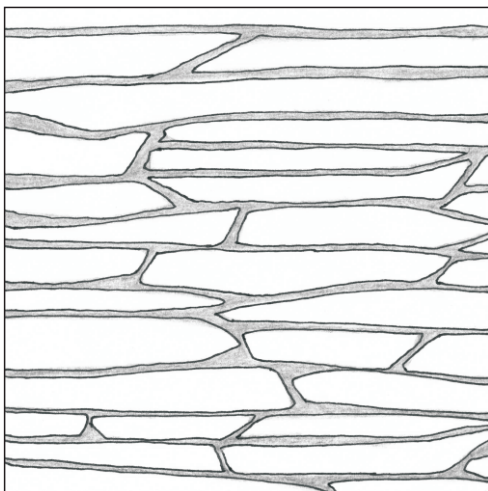

0018 ■ 50xL

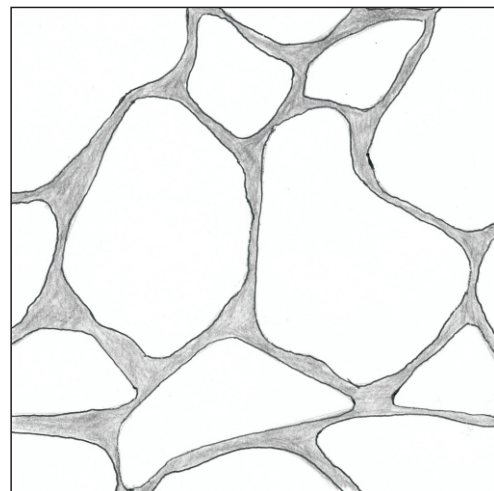

0039 Плоский булыжник

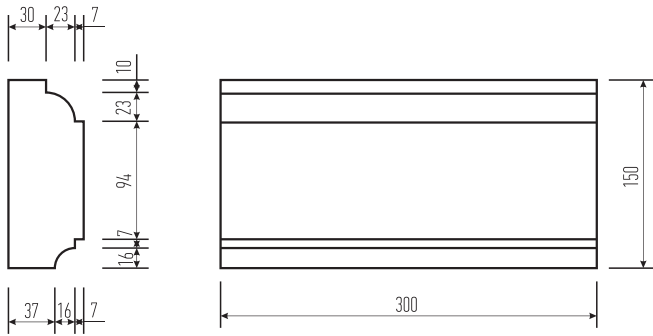

0001 Карниз

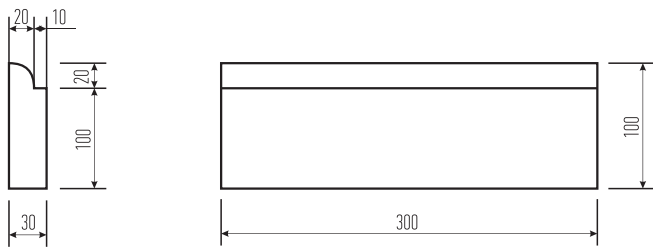

0002 Плинтус

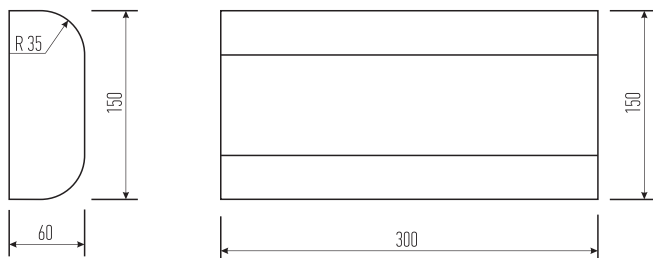

0003 Карниз

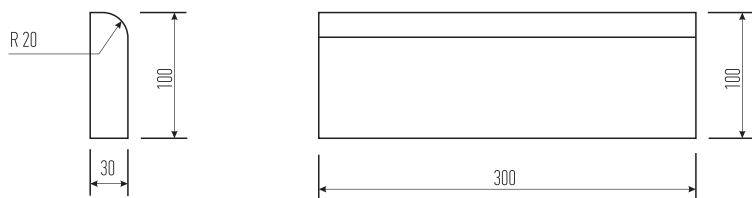

0004 Плинтус

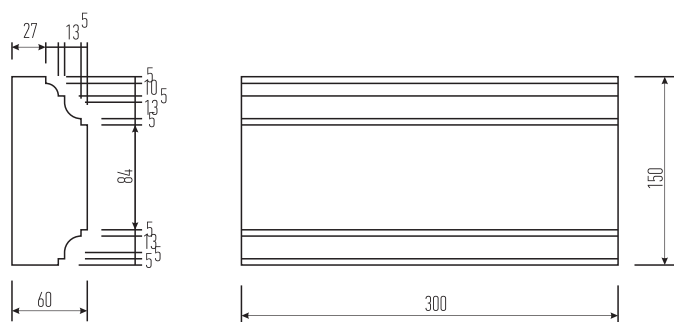

0005 Карниз

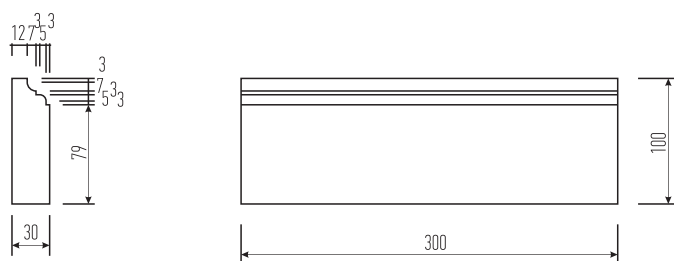

0006 Плинтус

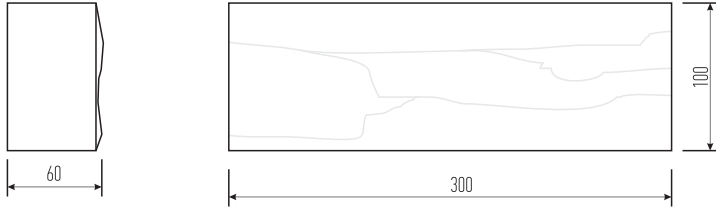

0007 Карниз

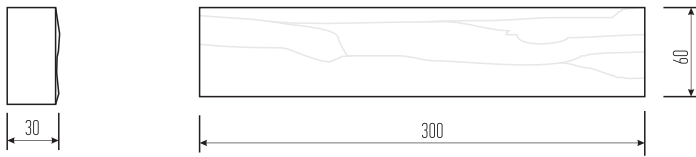



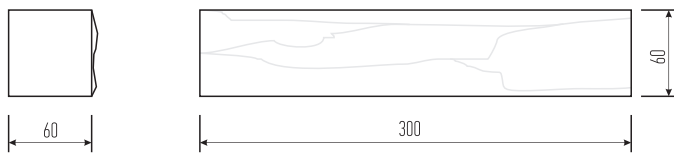







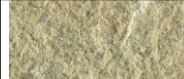

0008 Плинтус

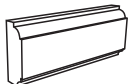

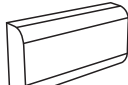
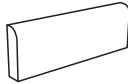
0009 Карниз

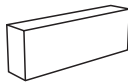

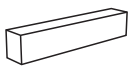
0010 Плинтус

						
		Лемезит	Песчаник	Кварцит	Златолит	Доломит
	0001 Карниз	0001	0002	0003	0004	0005
	0002 Плинтус	0006	0007	0008	0009	0010
	0003 Карниз	0011	0012	0013	0014	0015
	0004 Плинтус	0016	0017	0018	0019	0020
	0005 Карниз	0021	0022	0023	0024	0025
	0006 Плинтус	0026	0027	0028	0029	0030
	0007 Карниз	0031	0032	0033	0034	0035
	0008 Плинтус	0036	0037	0038	0039	0040
	0009 Карниз	0041	0042	0043	0044	0045
	0010 Плинтус	0046	0047	0048	0049	0050

